

**Sigma-XT**  
**Fire Alarm and**  
**Extinguishant System**  
**Warning Signs**  
**Installation and**  
**Operations Manual**  
**Serial Communications Type**

**Index Page**

**Table of Contents**

1 Overview..... 3

2 Installation..... 3

3 Cabling..... 4

4 Configuration..... 5

    4.1 485 Serial Connected..... 5

        4.1.1 Functions ..... 5

        4.1.2 Addressing ..... 5

    4.2 All Signs..... 5

5 Connections..... 6

    5.1 485 Serial Connected..... 6

    5.2 NON 485 Serial Connected ..... 7

6 Technical specification..... 8

# 1 Overview

The illuminated warning signs provide a clear, visual and audible warning for a variety of applications. Standard units are available to provide warning of a fire alarm or extinguishant release but the display may be customised to show any text on several coloured backgrounds.

Warning signs have two levels of operation in which the top and bottom halves of the sign may be split to show an initial warning and then additional text for a reinforced warning, or if required both halves can be activated at once.

The two levels may be activated either by a common and two switched signals, or by the Serial 485 bus from the Sigma XT control panel.

Up to 7 devices can be mixed along with status units and ancillary boards when utilising the serial bus. The serial bus connected units require a 4 core connection comprising 24V DC supply and the communications bus.

The signs are suitable for Fire, Extinguishant, Security and any other type of alarm system, and have a wide operating voltage from 15 to 30 Volts DC making them suitable for a wide range of applications.

The use of high brightness, white LED indicators minimises power consumption and maximises reliability.

# 2 Installation

Remove the front plate and use the back box as a template to mark the three fixings in the required position on the mounting surface. The back box must be fixed level and in all three mounting positions on a flat surface using bolts or screws with a minimum diameter of 4mm.

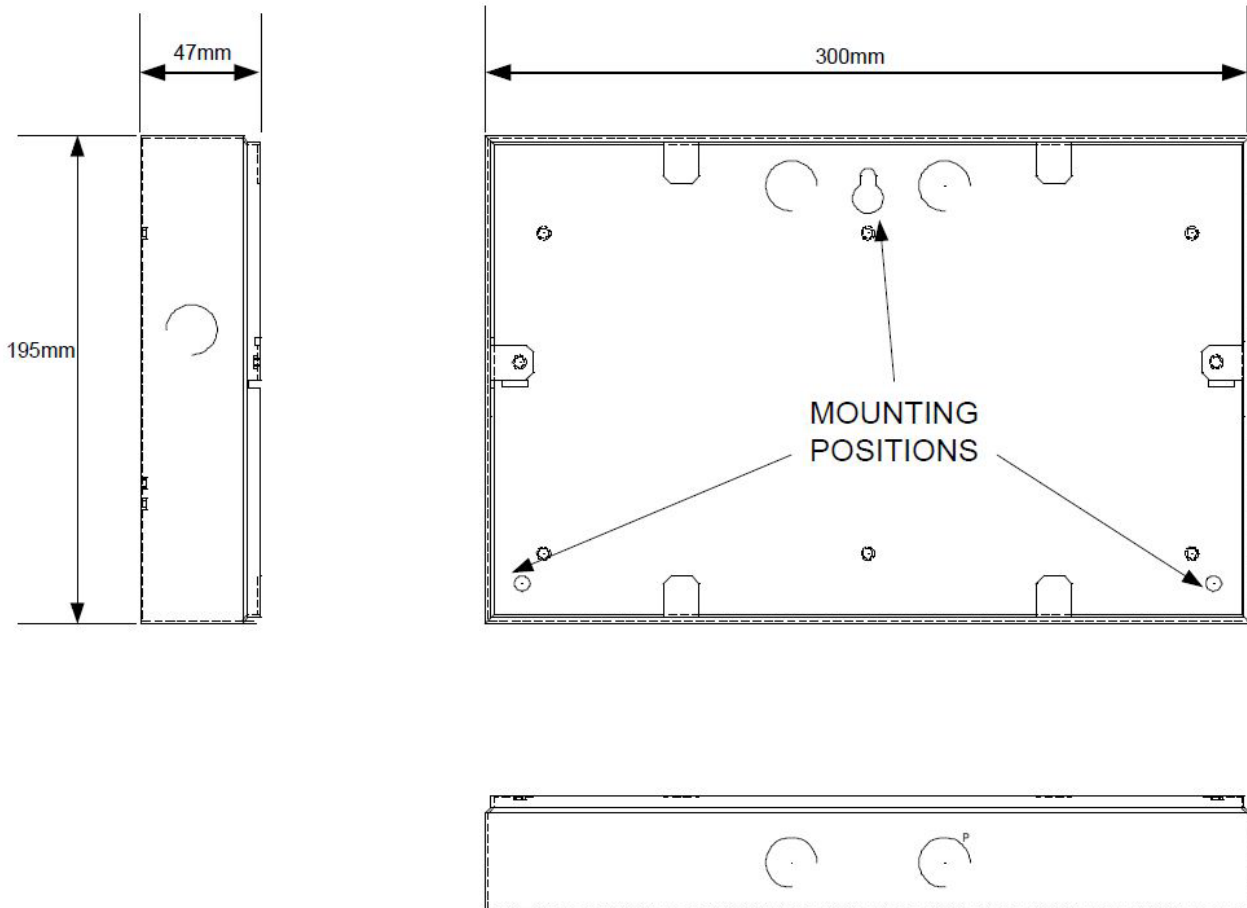

### 3 Cabling

The back box has two 20mm knockouts in the top, bottom and back and one 20mm knockout tin each side. Knockouts can be removed by sharply tapping them and when loose, pushing them back and forth until they break off.

The maximum size of cable that the terminals will accommodate is 2.5mm<sup>2</sup>. Cables should be connected using suitable cable glands, should have tails of sufficient length to reach the required terminals, and should be wired according to the relevant standards, including AS3000

Do not install cables across the front surface of the circuit board as this will impair the light output of the unit, and the shadows generated by the cables will be clearly visible when the sign is lit.

CORRECT WIRING

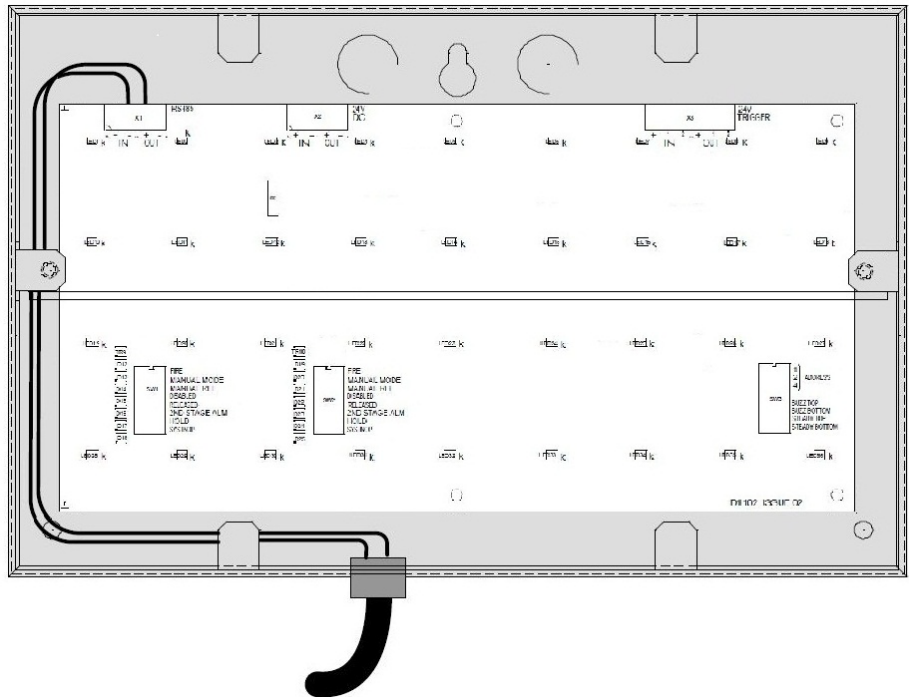

INCORRECT WIRING

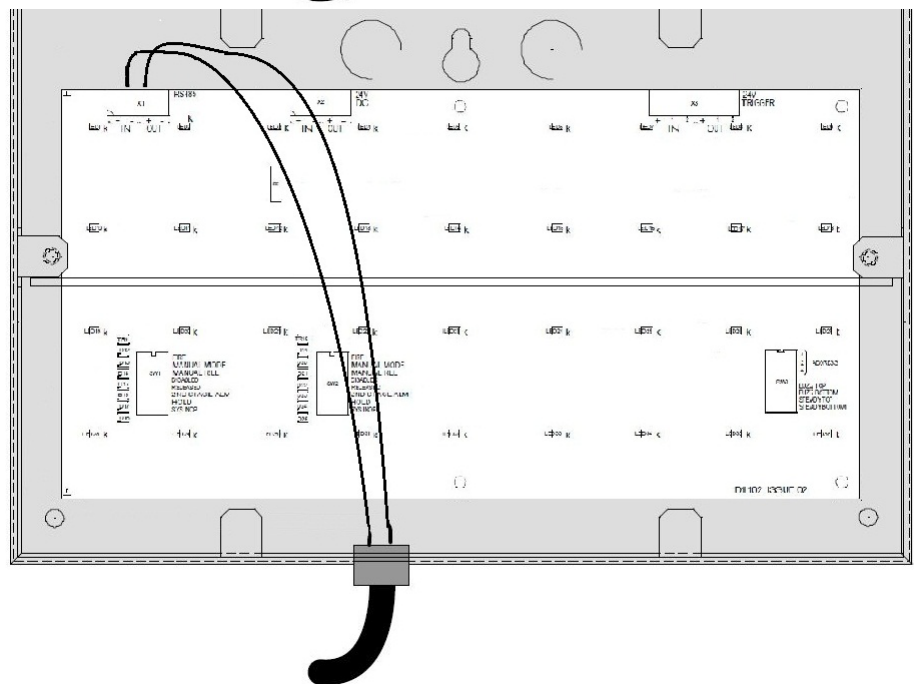

## 4 Configuration

The warning sign can be configured to illuminate in a variety of signals from the serial bus by setting the DIP switch. Separate DIP switches are provided for the top and bottom sections of the warning sign.

### 4.1 485 Serial Connected

#### 4.1.1 Functions

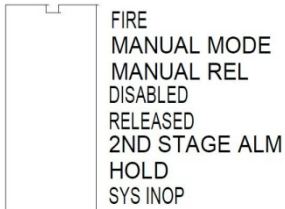

FIRE	The sign will illuminate on a fire signal.
MANUAL MODE	The extinguishant system has been places in Manual mode
MANUAL RELEASE	The manual release on the extinguishant system has been activated
DISABLE	A section of the fire or the extinguishant system has been disabled
RELEASED	The extinguishant has been released.
2 <sup>ND</sup> STAGE ALARM	The ECU has received a second fire alarm and is in second stage of releasing extinguishant
HOLD	The hold input in the risk has been activated
SYS INOP	A part of the extinguishant system or the fire alarm has been disabled or is in fault, including activation of the hold or abort inputs, placing the ECU in manual mode, or a comms fault on the ECU. The sign will also illuminate on loss of 485 communications.

#### 4.1.2 Addressing

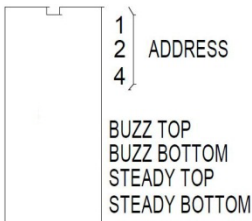

ADDRESS	The address is set in binary notation on the 4 way DIL switch.
---------	--

### 4.2 All Signs

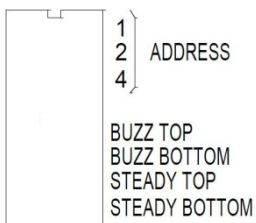

NOT USED	Bit 4 of the DIL switch is not used.
BUZZ	The warning sign buzzer will sound when the nominated section of the warning sign activates.
STEADY	The nominated section of the warning sign will come on steady when activated, otherwise it will flash.

# 5 Connections

## 5.1 485 Serial Connected

Note: Only 3 warning signs are to be permitted to be connected to the 24V “Status Power” output on the Sigma XT panel. Should more than 3 signs be required, they must be powered from the 24V supply protected via a separate inline fuse.

Up to 3 additional “clean contact” type signs may be installed from the trigger terminals of each 485 connected sign, in which case the sign must be powered directly from the 24V supply. See Section 5.2

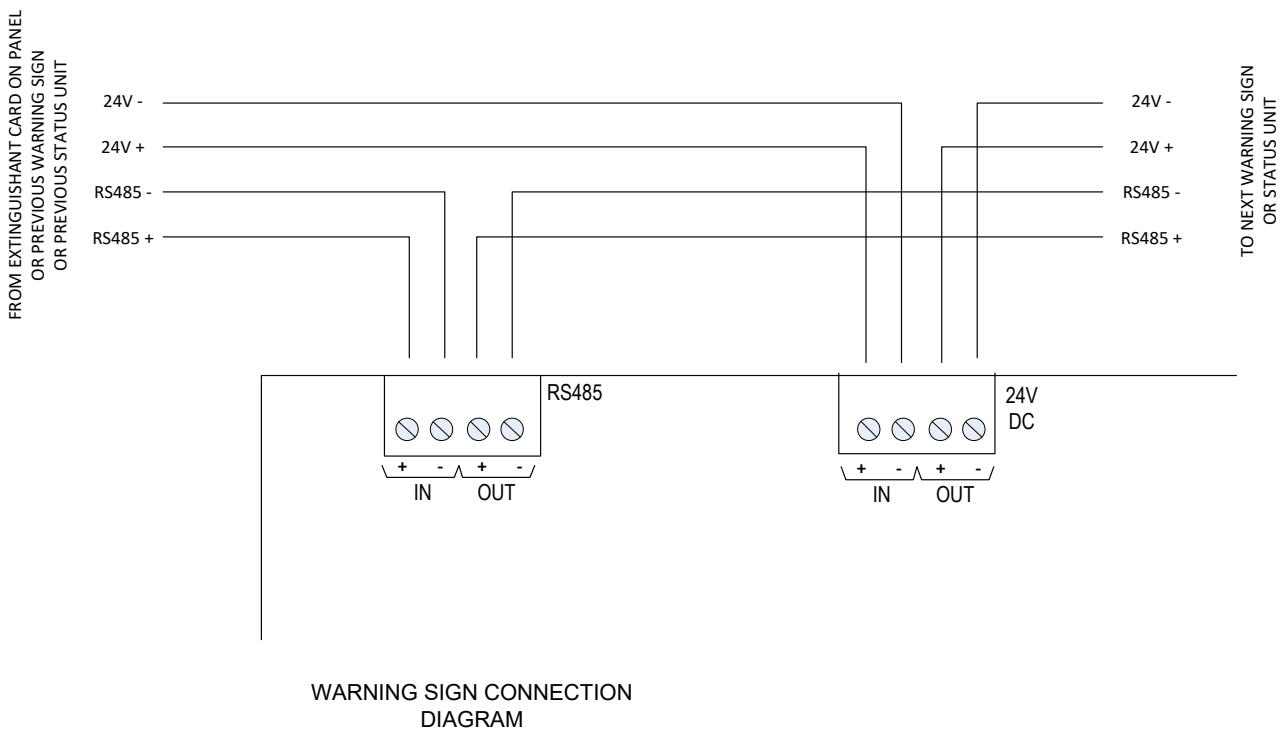

All connections for field wiring are to rows of terminals along the top of the circuit board, and should be wired according to the relevant standards, including AS3000. Shielded cable should be used for the 485 comms with the shield securely bonded to the cabinet. It is permissible to use shielded 4 core fire alarm cable. The resistance of any core of any cable must not exceed 2.5 ohms.

Wiring should enter the enclosure and be formed tidily to the appropriate terminals which are capable of accepting wires of up to 2.5mm<sup>2</sup>. Wiring must never pass across the front of the circuit board. If cable entries need to be in positions other than at the knockouts provided, wiring must be fed well away from the surface of the circuit board.

## 5.2 NON 485 Serial Connected

When 485 communications is not used, wiring must be terminated to 24V Trigger terminals.

**Note:** This connection is not suitable for the System Inoperative sign which will illuminate on loss of 485 communications.

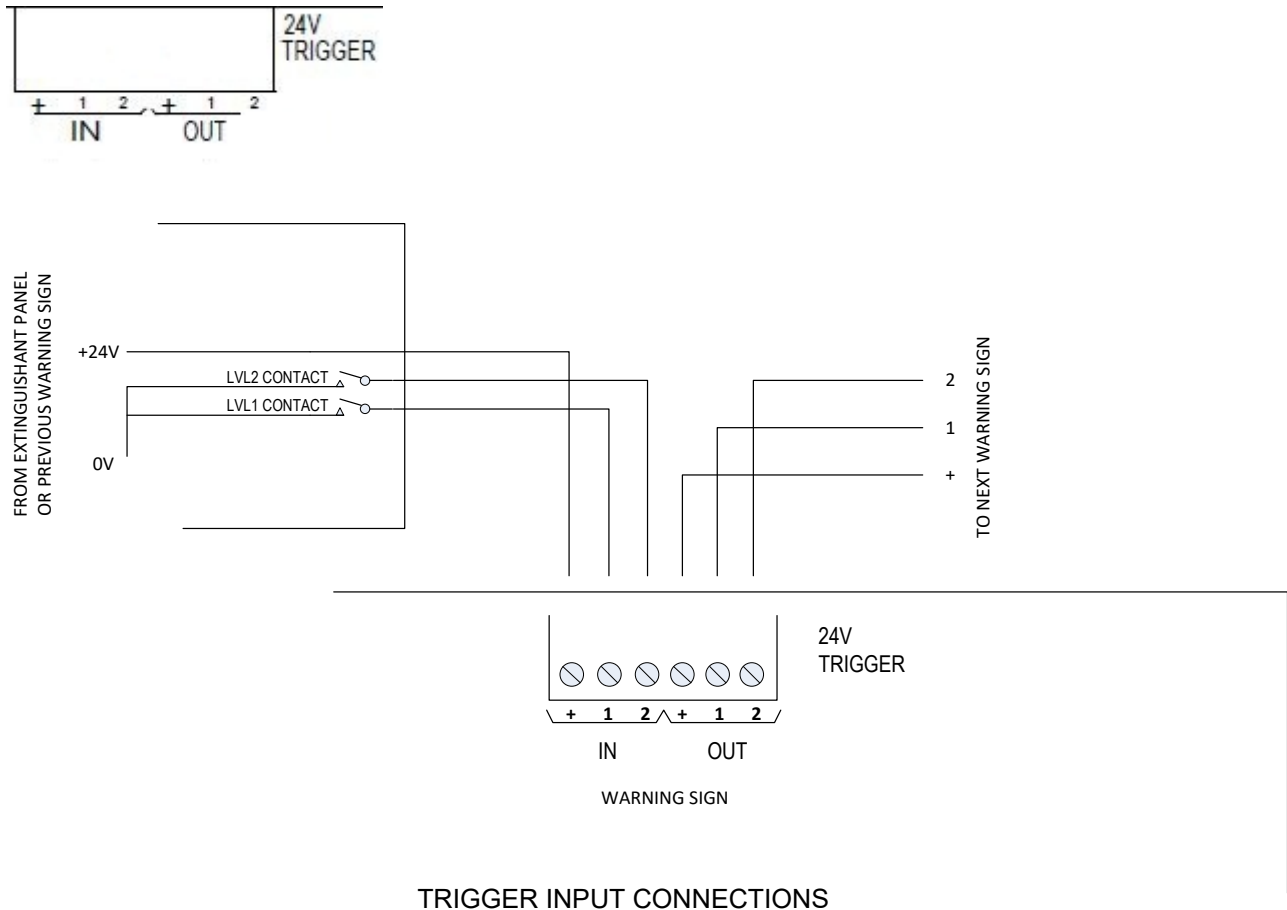

Warning signs may be wired in series with the proviso that fire control panel end of the cabling run should be connected to the IN and the next warning sign should be connected to the OUT.

Connecting the + supply to the + terminal and the – supply to the 1 terminal will illuminate the lower half of the sign as shown below.

Connecting the + supply to the + terminal and the – supply to the 2 terminal will illuminate the upper half of the sign as shown below.

Connecting the + supply to the + terminal and the – supply to both 1 the 2 terminals will illuminate both halves of the sign as shown below.

Up to 3 additional signs may be installed from the trigger terminals of each 485 connected sign, in which case the sign must be powered directly from the 24V supply. See Section 5.1



#2 input operated



#1 input operated



#1 and #2 inputs operated

## 6 Technical specification

Size	300mm X 195mm X 50mm
Construction	1.2mm filly welded sheet steel
IP Rating	IP40
Finish	Epoxy powder coated
Colour (lid and box)	BS00 A 05 grey fine texture
Operating voltage	15V to 30V DC
Current consumption	35 milliamps Quiescent 140 milliamps at 24V DC (both halves of sign lit and buzzer sounding)
Operating temperature	-5 to + 50 degrees C
Operating humidity	To 95% non-condensing
Sounder output	Maximum current limited by circuit that supplies the warning sign with power.



## **Sydney**

Block Y, Unit 1, 391 Park Road, REGENTS PARK NSW 2143  
Mail: PO Box 508 GYMEA NSW 2227  
Phone: 1300 INCITE (1300 462 483) | 02 9644 7144  
Fax: 02 9644 7255  
Email: [sales@incitefire.com.au](mailto:sales@incitefire.com.au)  
Technical support: [support@incitefire.com.au](mailto:support@incitefire.com.au)

## **Melbourne**

Address: Unit 120, 45 Gilby Road, MT WAVERLEY VIC 3149  
Phone: 03 9544 2211  
Fax: 03 9544 2212  
Email: [salesvic@incitefire.com.au](mailto:salesvic@incitefire.com.au)

## **Brisbane**

Address: 25 Jeays Street, BOWEN HILLS QLD 4006  
Phone: 07 3252 5366  
Fax: 07 3252 4099  
Email: [salesqld@incitefire.com.au](mailto:salesqld@incitefire.com.au)

## **Perth**

Address: Unit 2, 48 Irvine Drive, MALAGA WA 6090  
Phone: 08 9349 2972  
Email: [saleswa@incitefire.com.au](mailto:saleswa@incitefire.com.au)